

SYSTEMBAUGRUPPE D1107
SYSTEM BOARD D1107

TECHNISCHES HANDBUCH
TECHNICAL MANUAL

Sie haben ...

... technische Fragen oder Probleme?

Wenden Sie sich bitte an:

- einen unserer Servicepartner
- Ihren zuständigen Vertriebspartner
- Ihre Verkaufsstelle

Die Adressen Ihrer Servicepartner finden Sie im Garantieheft oder im Service-Adressenheft.

Aktuelle Informationen zu unseren Produkten, Tipps, Updates usw. finden Sie im Internet:

<http://www.fujitsu-siemens.com>

Is there ...

... any technical problem or other question you need clarified?

Please contact:

- one of our service partners
- your sales partner
- your sales outlet

The addresses of your service partners are contained in the guarantee booklet or in the service address booklet.

The latest information on our products, tips, updates, etc., can be found on the Internet under:

<http://www.fujitsu-siemens.com>



Dieses Handbuch wurde auf Recycling-Papier gedruckt.
This manual has been printed on recycled paper.
Ce manuel est imprimé sur du papier recyclé.
Este manual ha sido impreso sobre papel reciclado.
Questo manuale è stato stampato su carta da riciclaggio.
Denna handbok är tryckt på recyclingpapper.
Dit handboek werd op recycling-papier gedrukt.

Herausgegeben von/Published by
Fujitsu Siemens Computers GmbH

Bestell-Nr./Order No.: **A26361-D1107-Z120-1-7419**
Printed in the Federal Republic of Germany
AG 0100 01/00



A26361-D1107-Z120-1-7419

Deutsch

English

**Systembaugruppe
D1107
System Board D1107**

**Technisches Handbuch
Technical Manual**

**Ausgabe Januar 2000
January 2000 edition**

Intel, Pentium und Celeron sind eingetragene Warenzeichen und MMX und OverDrive sind Warenzeichen der Intel Corporation, USA.

Microsoft, MS, MS-DOS und Windows sind eingetragene Warenzeichen der Microsoft Corporation.

PS/2 und OS/2 Warp sind eingetragene Warenzeichen von International Business Machines, Inc.

Magic Packet ist ein eingetragenes Warenzeichen von Advanced Micro Devices, Inc.

Rambus, RDRAM, und das Rambus Logo sind eingetragene Warenzeichen der Rambus Inc. Direct Rambus, RIMM, SO-RIMM und Direct RDRAM sind Warenzeichen von Rambus Inc.

Alle weiteren genannten Warenzeichen sind Warenzeichen oder eingetragene Warenzeichen der jeweiligen Inhaber und werden als geschützt anerkannt.

Alle Rechte vorbehalten, insbesondere (auch auszugsweise) die der Übersetzung, des Nachdrucks, der Wiedergabe durch Kopieren oder ähnliche Verfahren.

Zu widerhandlungen verpflichten zu Schadenersatz.

Alle Rechte vorbehalten, insbesondere für den Fall der Patenterteilung oder GM-Eintragung.

Liefermöglichkeiten und technische Änderungen vorbehalten.

Copyright © Fujitsu Siemens Computers GmbH 2000

Intel, Pentium and Celeron are registered trademarks and MMX and OverDrive are trademarks of Intel Corporation, USA.

Microsoft, MS, MS-DOS and Windows are registered trademarks of Microsoft Corporation.

PS/2 and OS/2 Warp are registered trademarks of International Business Machines, Inc.

Magic Packet is a registered trademark of Advanced Micro Devices, Inc.

Rambus, RDRAM, and the Rambus Logo are registered trademarks of Rambus Inc. Direct Rambus, RIMM, SO-RIMM, and Direct RDRAM are trademarks of Rambus Inc.

All other trademarks referenced are trademarks or registered trademarks of their respective owners, whose protected rights are acknowledged.

All rights, including rights of translation, reproduction by printing, copying or similar methods, even of parts are reserved.

Offenders will be liable for damages.

All rights, including rights created by patent grant or registration of a utility model or design, are reserved. Delivery subject to availability.

Right of technical modification reserved.

Contents

Introduction.....	1
Notational conventions	1
Important notes	1
Information on boards.....	2
Features	3
Interfaces and connectors	5
Temperature monitoring / system monitoring	7
LAN port	8
Resource table	9
PCI bus interrupts.....	9
Settings with switches	10
Recovering System BIOS - switch 2	11
Write protection for floppy disks - switch 3	11
Clock frequency - switches 5 to 8	11
Add-on modules	13
Installing / removing processor	14
Upgrading main memory.....	15
Installing network board with WOL.....	16
Replacing the lithium battery.....	16
Glossary	17

Introduction



These system boards are available in different configuration levels. Depending on the hardware configuration of your device, it may be that you cannot find several options in the system board, even though they are described.

You may find further information in the description "BIOS Setup".

Notational conventions

The meanings of the symbols and fonts used in this manual are as follows:



Pay particular attention to texts marked with this symbol. Failure to observe this warning endangers your life, destroys the system, or may lead to loss of data.



Supplementary information, remarks and tips follow this symbol.

► Texts which follow this symbol describe activities that must be performed in the order shown.

▬ This symbol means that you must enter a blank space at this point.



This symbol means that you must press the Enter key.

Texts in this typeface are screen outputs.

Texts in this bold typeface are the entries you make via the keyboard.

Texts in *italics* indicate commands or menu items.

"Quotation marks" indicate names of chapters and terms that are being emphasized.

Important notes

Store this manual close to the device. If you pass on the device to third parties, you should also pass on this manual.



Be sure to read this page carefully and note the information before you open the device.

You cannot access the components of the system board without first opening the device. How to dismantle and reassemble the device is described in the Operating Manual accompanying the device.

Please note the information provided in the chapter "Safety" in the Operating Manual of the device.

Incorrect replacement of the lithium battery may lead to a risk of explosion. It is therefore essential to observe the instructions in the chapter „[Add-on modules](#)“ - „[Replacing the lithium battery](#)“.



The shipped version of this board complies with the requirements of the EEC directive 89/336/EEC "Electromagnetic compatibility".

Compliance was tested in a typical PC configuration.

When installing the board, refer to the specific installation information in the Operating Manual or Technical Manual of the receiving device.

Connecting cables for peripherals must be adequately insulated to avoid interference.



Components can become very hot during operation. Make sure you do not touch components when making extensions to the system board. There is a danger of burns!



The warranty is invalidated if the device is damaged during the installation or replacement of system expansions. Information on which system expansions you can use is available from your sales outlet or the customer service center.

Information on boards

To prevent damage to the system board or the components and conductors on it, please take great care when you insert or remove boards. Take care above all to ensure that extension boards are slotted in straight without damaging components or conductors on the system board, or any other components, for example EMI spring contacts.

Be especially careful with the locking mechanisms (catches, centering pins etc.) when you replace the system board or components on it, for example memory modules or processors.

Never use sharp objects (screwdrivers) for leverage.



Boards with electrostatic sensitive devices (ESD) are identifiable by the label shown.

When you handle boards fitted with ESDs, you must observe the following points under all circumstances:

- You must always discharge yourself (e.g. by touching a grounded object) before working.
- The equipment and tools you use must be free of static charges.
- Pull out the power plug before inserting or pulling out boards containing ESDs.
- Always hold boards with ESDs by their edges.
- Never touch pins or conductors on boards fitted with ESDs.

Features

The components and connectors marked do not have to be present on the system board.

- System board in ATX format
- Intel Pentium II processor with 100 MHz or 66 MHz Front Side Bus for slot 1 processor socket
or
- Intel Pentium III processor with 100 MHz Front Side Bus for slot 1 processor socket
or
- Intel Celeron processor with 66 MHz Front Side Bus for slot 1 processor socket

Intel Pentium II / III and Celeron processors support MMX technology. Size and frequency of first-level cache and second-level cache are depending on the processor used.

- Intel chipset 440BX / PIIX4E
- Intel 82559 LAN controller (10/100 Mbit/s) with RJ45 interface
WOL with Magic Packet™ is supported, as is booting from LAN with Bootix LAN BootP or Intel LSA.
- Fujitsu Siemens system monitoring and temperature management
- 3 DIMM slots for 16 to 768 Mbyte main memory (SDRAM memory modules)
- Flash BIOS
- Energy saving functions
 - ACPI S3 / Save-to-RAM (requires an operating system that supports ACPI).
 - ACPI S4 / Save-to-Disk (requires an operating system that supports ACPI).
 - APM
- Security functions:
 - Chipcard reader interface
 - Detection of unauthorized opening of the housing
 - Simple error detection and correction in the main memory with an ECC
 - System, Setup and Keyboard password
 - parallel and serial ports can be deactivated
 - Write protection for floppy disk drive
 - Virus warning function for the boot hard disk
 - Virus protection function for the flash BIOS and the EEPROMs on the memory modules
- 1 AGP slot, 4 PCI slots
AGP and PCI slots support 3.3 V main and auxiliary voltages.
- 1 ISA/PCI slot (shared) and 1 ISA slot or 2 ISA slots

- IDE hard disk controller connected to PCI bus for up to four IDE drives (e.g. IDE hard disk drives, ATAPI CD-ROM drives)
The IDE hard disk controller are ultra DMA33 mode capable and support PIO modes 0-4.
- Floppy disk drive controller (possible formats: 720 Kbyte, 1.44 Mbyte)
- The system board supports booting from a 120 Mbyte IDE floppy disk drive.
- 1 external parallel interface (ECP- and EPP-compatible)
- 1 external serial port (16C550 compatible with FIFO)
- 1 internal chipcard reader interface As an alternative this interface can also be used as a second serial port (16C550 compatible with FIFO).
- 1 internal WOL interface
- 2 external PS/2 interfaces for keyboard and mouse
- 2 external USB ports (USB = Universal Serial Bus)
- 1 connector for internal infrared connection
- Real-time clock/calendar with integrated battery backup

Interfaces and connectors

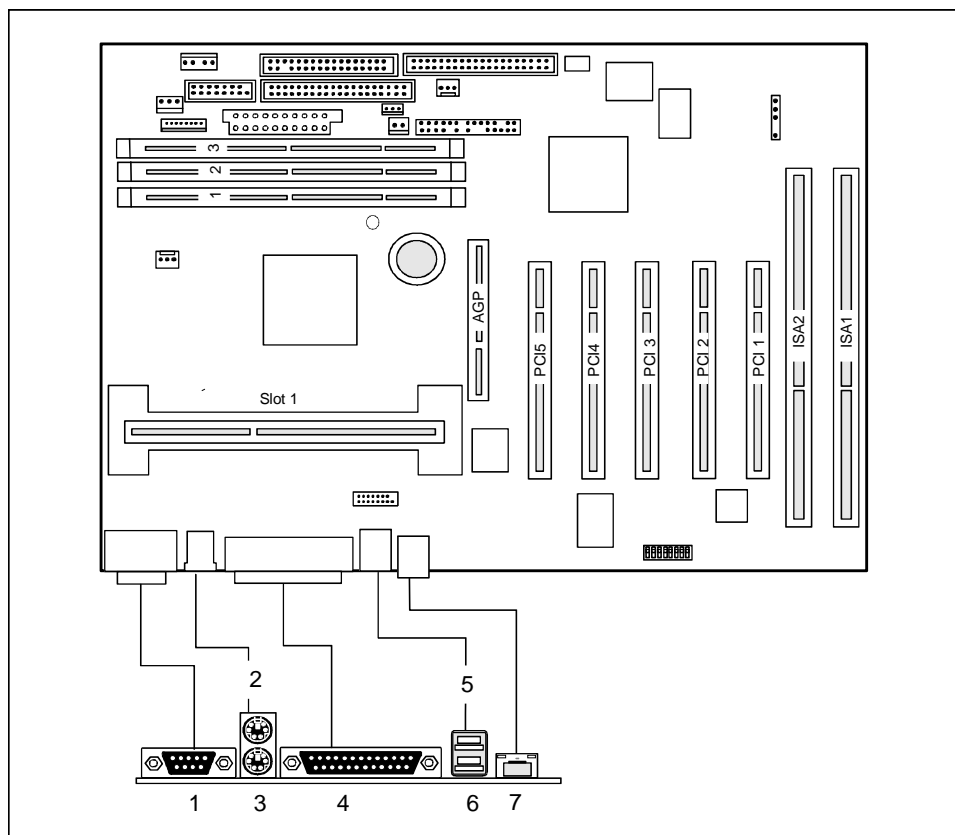

1 = Serial port 1
 2 = PS/2 mouse port
 3 = PS/2 keyboard port

4 = Parallel port
 5 = USB port 2
 6 = USB port 1
 7 = LAN port

The components and connectors marked do not have to be present on the system board.

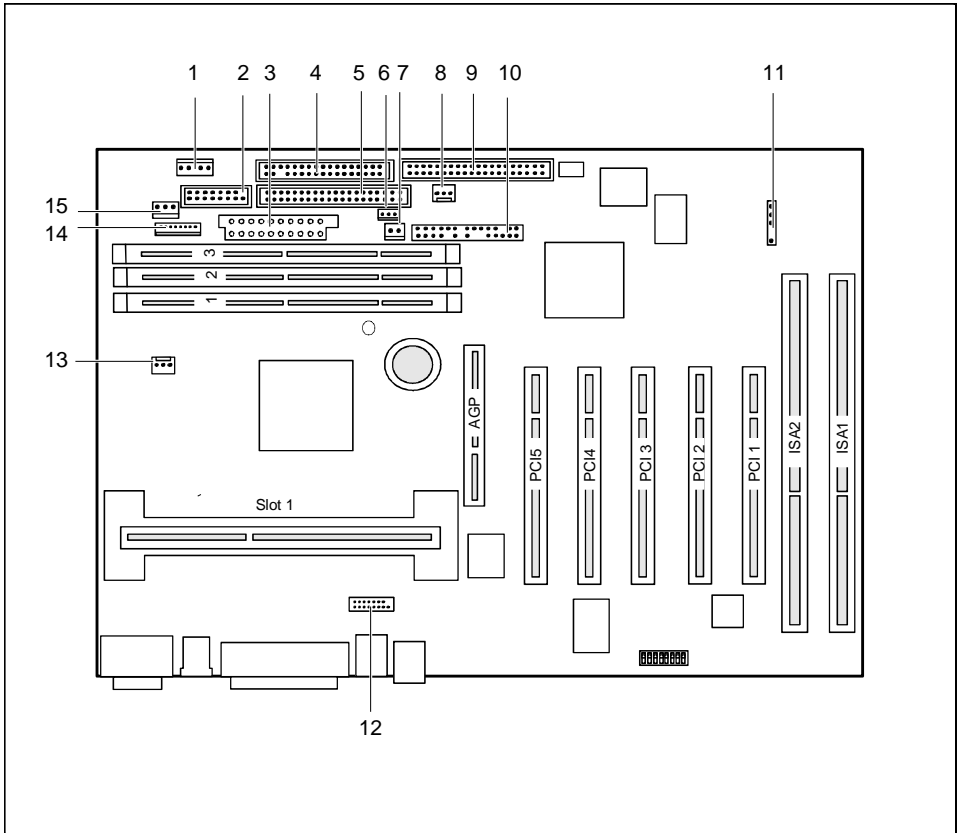

- 1 = I²C connector
- 2 = Serial chipcard reader interface or serial port 2
- 3 = Power supply
- 4 = Floppy disk drive
- 5 = IDE drives 3 and 4 (secondary)
- 6 = Wake On LAN
- 7 = ON/OFF switch
- 8 = Fan 2

- 9 = IDE drives 1 and 2 (primary)
- 10 = Connector for front panel
- 11 = IrDA
- 12 = USB chipcard reader
- 13 = Fan 1 (e. g. for the processor)
- 14 = Power supply monitoring
- 15 = Cover monitoring

The components and connectors marked do not have to be present on the system board.

Temperature monitoring / system monitoring

One goal of temperature and system monitoring is to reliably protect the computer hardware against damage caused by overheating. In addition, any unnecessary noise is also to be prevented with a reduced fan speed, and information is to be provided on the system state. The cover monitoring protects the system from unauthorized opening.

The temperature and system monitoring are controlled by an onboard controller developed by Fujitsu Siemens.

The following functions are supported:

Temperature monitoring:

Measurement of the processor temperature, measurement of the system temperature with an onboard temperature sensor, measurement of the device temperature with an optional temperature sensor (AUX).

Temperature control:

The temperature is controlled with the fan speed and/or by reducing the clock frequency of the processor. The clock frequency of the processor is dependent on the setting in the *BIOS setup*. Temperature-dependent processor speed control enables a reduced fan speed, decreasing noise.

Fan monitoring:

Fans that are no longer available, blocked or sticky fans are detected. Blocked or sticky fans are operated with 12 V pulse voltage. Fans removed while the system is switched off are signaled by the *Display news* LED when the system is switched on again and processed by the BIOS or the application.

Fan control:

The fans are regulated according to temperature (exception: auxiliary fan (AUX)).

Sensor monitoring:

A fault or removal of a temperature sensor is detected. In this case all fans affected by this sensor run at maximum speed to achieve the greatest possible protection of the hardware. Temperature sensors removed while the system is switched off are signaled by the *Display news* LED and processed by the BIOS or the application.

Cover monitoring:

Unauthorized opening of the cover is detected, even when the system is switched off. However, this will not be indicated until the system is operating again.

Voltage monitoring:

The voltages 12 V, 5 V and the CMOS battery are monitored.

With hardware monitoring - regardless of the operating system and processor - the advantages compared to conventional software monitoring are clear:

- suitable for all operating systems and processor types
- no additional load on processor (performance)
- optimum reliability, even if process faults or faults are present in the operating system
- optimum noise reduction

Three different operating modes are available and can be configured in *BIOS Setup - System Management*.

LAN port

This system board is equipped with the Intel 82559 LAN controller as an option. This LAN controller supports the transfer speeds 10 Mbit/s and 100 Mbit/s. The LAN controller is equipped with a 3 Kbyte transmission and receiving buffer (FIFO) and supports the WOL function through Magic Packet™.

It is also possible to boot a device without its own boot hard disk via LAN. Here Bootix LAN BootP and Intel LSA are supported.

The LAN RJ45 connector is equipped with a yellow and a green LED (light emitting diode).

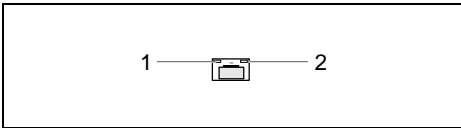

- 1 = Yellow indicator
- 2 = Green indicator

Green a connection exists (e. g. to a hub).

Yellow Link Mode: the LAN connection is active.
 WOL mode: a Magic Packet™ is being received.

Resource table

	assigned IRQ	possible IRQ	Possible Address (hex)	Possible DMA
Keyboard	IRQ1			
Serial interface COM1		3 4	03F8, 02F8 03E8, 02E8	
Serial port COM2		3 4	02E8, 02F8 03E8, 03F8	
Floppy disk drive controller	IRQ6			2
Parallel interface LPT1		5, 7	0278, 0378, 03BC	0, 1, 3
RTC	IRQ8			
USB controller			PnP	
Mouse controller	IRQ12			
Numeric processor	IRQ13			
IDE controller 1	IRQ14		01F0-01F7	
IDE controller 2	IRQ15		0170-0177	
LAN			PnP	

"assigned IRQ" = interrupts assigned as shipped

"Possible IRQ" = these interrupts can be used for your particular application

"Possible address" = this address can be used for your particular application

"Possible DMA" = these DMAs can be used for your particular application

PCI bus interrupts

The following table shows which PCI bus interrupts on the system board are assigned.

PCI bus interrupt	Component on system board:
A	PCI bus slot 5
A	PCI bus slot 1
A	AGP slot
B	PCI bus slot 2
C	PCI bus slot 3
D	PCI bus slot 4
D	USB controller
D	LAN controller

Settings with switches

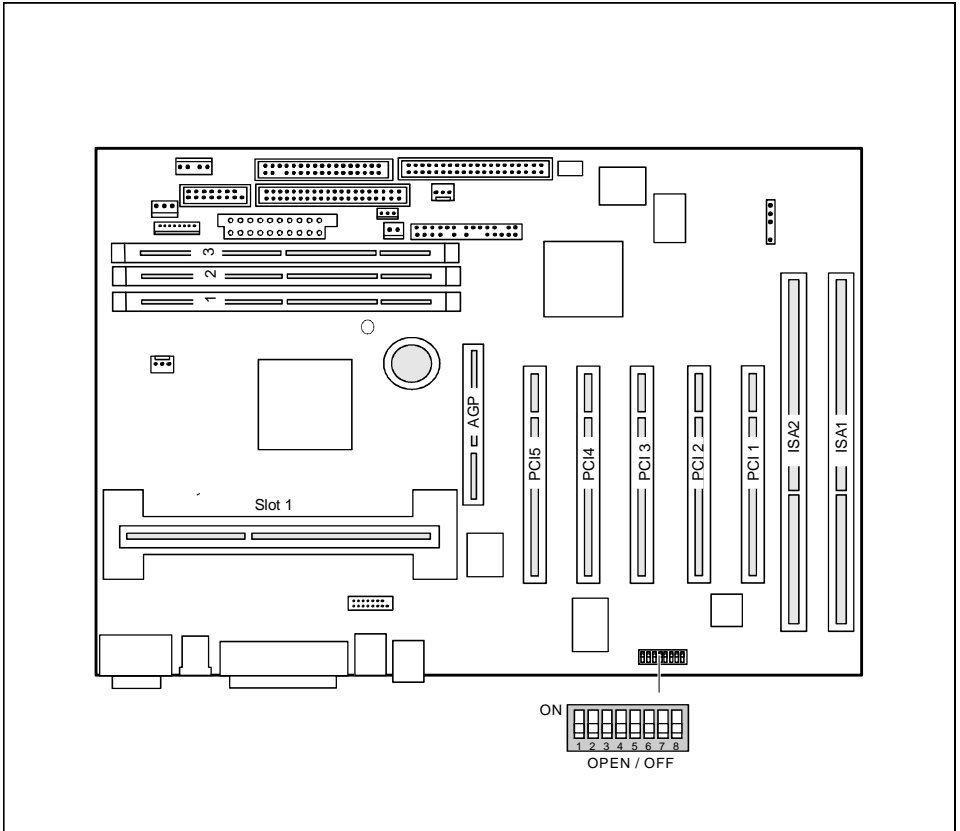

Switch 1 = must be set to *off*
Switch 2 = System BIOS recovery (RCV)
Switch 3 = Write protection for floppy disks

Switch 4 = reserved
Switches 5 - 8 = clock frequency

Recovering System BIOS - switch 2

Switch RCV enables recovery of the old system BIOS after an attempt to update has failed. To restore the old system BIOS you need a Flash BIOS Diskette (please call our customer service center).

On The System BIOS executes from standard floppy drive A: and the inserted "Flash-BIOS-Diskette" restores the System BIOS on the system board.

Off Normal operation (default setting).

Write protection for floppy disks - switch 3

Switch 3 is used to define whether floppy disks can be written or deleted in the standard floppy disk drive. To write and delete floppy disks, the write-protection in *BIOS Setup* must be disabled (in menu *Security*, the field *Diskette Write* must be set to *Enabled*).

On The standard floppy disk drive is write-protected.

Off Read, write and delete floppy disks is possible (default setting).

Clock frequency - switches 5 to 8



The switches may only be set as specified in the tables below for the particular processor used.

There are also processors, which automatically always operate at the proper frequency, regardless of the switch position.

As these new processors do not differ externally from the previous processors, we recommend always setting the switches in accordance with the processor.

This system board you may use with Pentium II processors with 66 MHz or 100 MHz Front Side Bus or with Pentium III processors with 100 MHz Front Side Bus or with Celeron processors with 66 MHz Front Side Bus.

Information on which processors can be used is available from your sales outlet or the customer service center.

Pentium II with 66 MHz Front Side Bus:

processor	switch 5	switch 6	switch 7	switch 8
300 MHz	off	on	off	on
333 MHz	on	off	off	on

Celeron with 66 MHz Front Side Bus:

processor	switch 5	switch 6	switch 7	switch 8
233 MHz	off	off	on	on
266 MHz	on	on	off	on
300 MHz	off	on	off	on
333 MHz	on	off	off	on
366 MHz	off	off	off	on
400 MHz	on	on	on	off
433 MHz	off	on	on	off
466 MHz	on	off	on	off
500 MHz	off	off	on	off
533 MHz	on	on	off	off

Pentium II with 100 MHz Front Side Bus:

processor	switch 5	switch 6	switch 7	switch 8
350 MHz	off	off	on	on
400 MHz	on	on	off	on
450 MHz	off	on	off	on

Pentium III with 100 MHz Front Side Bus:

processor	switch 5	switch 6	switch 7	switch 8
450 MHz	off	on	off	on
500 MHz	on	off	off	on
550 MHz	off	off	off	on
600 MHz	on	on	on	off
650 MHz	off	on	on	off
700 MHz	on	off	on	off
750 MHz	off	off	on	off
800 MHz	on	on	off	off

Add-on modules



For all steps described in this chapter exit the suspend mode before switching off the device and then pull the power plug out of the power outlet!
Even when you have run down the device, parts of the device (e. g. memory modules, AGP and PCI extension boards) are still energized.
Should this be the case, the voltage indicator LED glows.

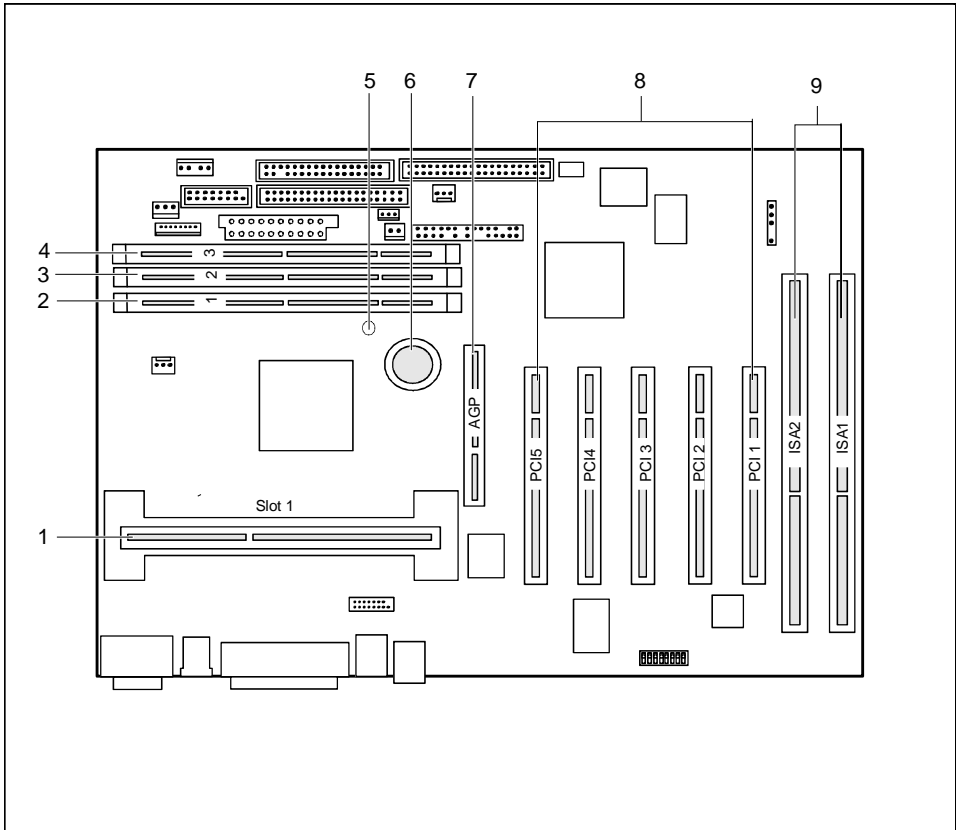

- 1 = Slot for processor with heat sink
- 2 = Location bank 1 for main memory
- 3 = Location bank 2 for main memory
- 4 = Location bank 3 for main memory
- 5 = Voltage indicator LED

- 6 = Lithium battery
- 7 = AGP slot
- 8 = PCI slots 1, 2, 3, 4, 5
- 9 = ISA slots 1, 2



AGP and PCI slots support 3.3 V main and auxiliary voltages.

The components and connectors marked do not have to be present on the system board.

Installing / removing processor

Installing the processor



If you wish to upgrade your system with a new processor, the processor bracket on the system board may need to be replaced beforehand. Should it be necessary to replace the bracket, please contact our customer service center.

Depending on the design of the processor housing, the heat sink can be moved on the processor and the processor in the bracket. This floating suspension in the installed state ensures reliable contact between the processor and the heat sink. Detents in the bracket prevent the processor from slipping out.

If the heat sink on the processor can be moved, then it must also be possible to move the mounted processor in the bracket. This ensures optimum cooling.

If you replace the processor, grasp the processor housing by the processor and the heat sink.

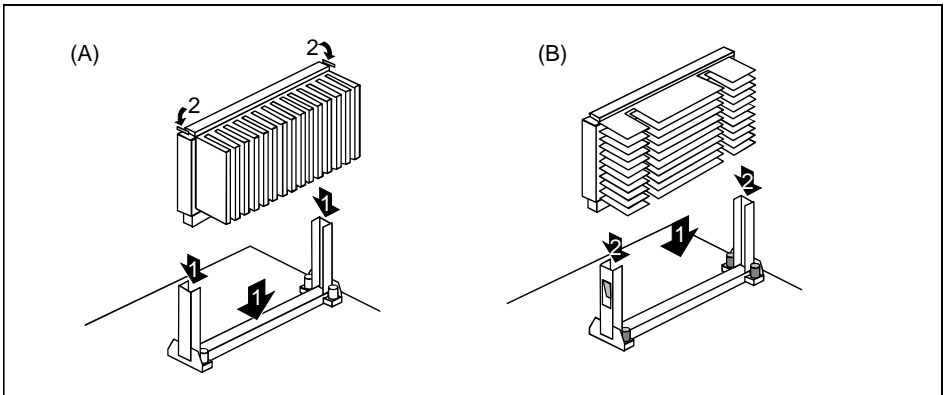

The illustration shows two bracket and processor models.

- ▶ Remove the old processor if necessary.
- ▶ Slide the processor into the bracket (1).
- ▶ Push the processor down in the bracket and press it into the slot until the clamps (2) to the left and right snap into place.
- ▶ Set the clock frequency of the new processor using switches 5 to 8 of the switch block.
- ▶ If the processor has a temperature sensor or a fan, attach the associated cable to the connector for the temperature sensor or the fan on the system board.

Removing the processor

- ▶ If the processor has a temperature sensor or a fan, pull out the associated cable.
- ▶ Press the clamps (2) on either side of the processor slightly inwards (A) or outwards (B) and pull the processor up and out. Use a screwdriver if necessary.

Upgrading main memory

These slots are suitable for 16, 32, 64, 128 and 256 Mbyte SDRAM memory modules of the DIMM format.

Memory modules with different memory capacities can be combined.



You may only use unbuffered 3.3V memory modules. Buffered memory modules are not permitted.

SDRAM memory modules must be designed for a clock frequency of 100 MHz or higher (meets PC100 specification).

Installing memory modules

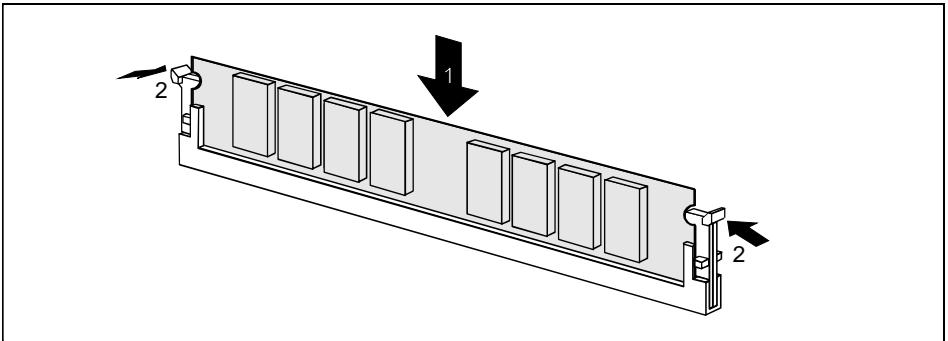

- ▶ Flip the holders on each side of the relevant location outwards.
- ▶ Insert the memory module in the slot while folding the side holders up until the memory module engages (2).

Removing a memory module

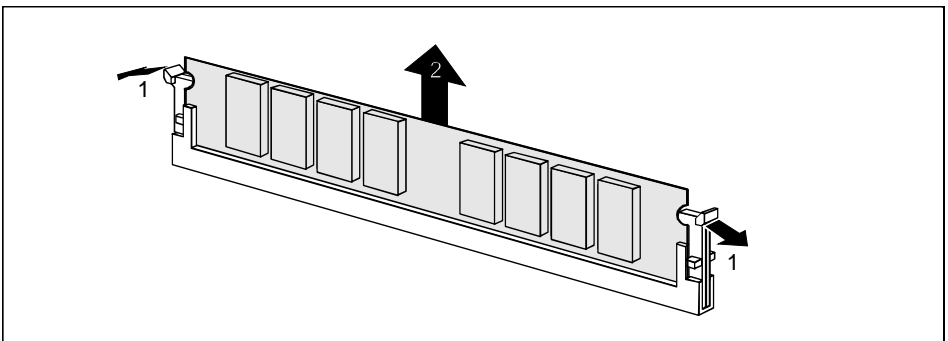

- ▶ Flip the holders to the right and left of the location outwards (1).
- ▶ Pull the memory module out of its location (2).

Installing network board with WOL

- ▶ Install the network board as described in the operating manual for your unit.
- ▶ Push the WOL cable onto the WOL plug connector of the system board.



To use the WOL functionality of a network board the power supply must provide a 5 V auxiliary voltage of at least 1 A. If the system board was not already incorporated in a device when you bought it you must check whether your power supply can provide the auxiliary voltage.

You may find further information in the supplied description of the network board.

Replacing the lithium battery



Incorrect replacement of the lithium battery may lead to a risk of explosion.

The lithium battery must be replaced with an identical battery or a battery type recommended by the manufacturer (CR2032).

Do not throw lithium batteries into the trashcan. It must be disposed of in accordance with local regulations concerning special waste.

Make sure that you insert the battery the right way round. The plus pole must be on the top!

- **VAROITUS**
Paristo voi räjähtää, jos se on virheellisesti asennettu. Vaihda paristo ainoastaan laitevalmistajan suosittelemaan tyyppiin. Hävitä käytetty paristo valmistajan ohjeiden mukaisesti.
- **VARNING**
Explosionsfara vid felaktigt batteribyte. Använd samma batterityp eller en ekvivalent typ som rekommenderas av apparattillverkaren. Kassera använt batteri enligt fabrikantens instruktion.
- **ADVARSEL**
Lithiumbatteri - Explosionsfare ved fejlagtig håndtering. Udskiftning må kun ske med batteri af samme fabrikat og type. Lever det brugte batteri tilbage til leverandøren.
- **ADVARSEL**
Explosionsfare ved feilaktig skifte av batteri. Benytt samme batteritype eller en tilsvarende type anbefalt av apparatfabrikanten. Brukte batterier kasseres i henhold til fabrikantens instruksjoner.

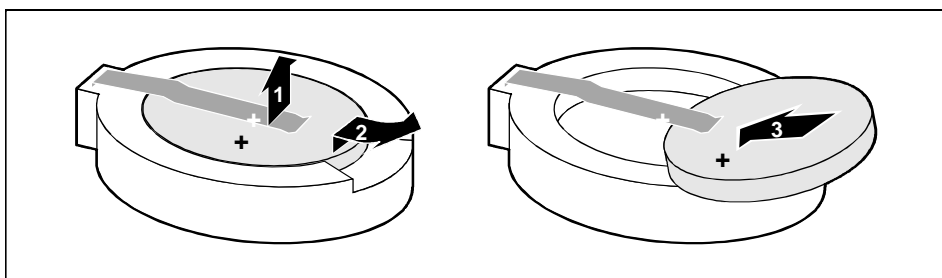

- ▶ Lift the contact (1) a few millimeters and remove the battery from its socket (2).
- ▶ Insert a new lithium battery of the same type in the socket (3).

Glossary

The technical terms and abbreviations given below represent only a selection of the full list of common technical terms and abbreviations.

Not all technical terms and abbreviations listed here are valid for the described system board.

ACPI.....	Advanced Configuration and Power Interface
AC'97	Audio Codec '97
AGP	Accelerated Graphics Port
AMR	Audio Modem Riser
AOL.....	Alert On LAN
APM	Advanced Power Management
ATA	Advanced Technology Attachment
BIOS	Basic Input Output System
CAN.....	Controller Area Network
CPU.....	Central Processing Unit
C-RIMM.....	Continuity Rambus Inline Memory Module
DIMM.....	Dual Inline Memory Module
ECC.....	Error Correcting Code
EEPROM.....	Electrical Erasable Programmable Read Only Memory
FDC.....	Floppy Disk Controller
FIFO.....	First-In First-Out
FSB	Front Side Bus
FWH.....	Firmware Hub
GMCH.....	Graphics and Memory Controller Hub
I ² C	Inter Integrated Circuit
IAPC.....	Instantly Available Power Managed Desktop PC Design
ICH.....	I/O Controller Hub
IDE	Intelligent Drive Electronics
IPSEC	Internet Protocol Security
ISA	Industrial Standard Architecture
LAN	Local Area Network
LSA	LAN Desk Service Agent
MCH.....	Memory Controller Hub
MMX.....	MultiMedia eXtension
PCI	Peripheral Component Interconnect
PXE	Preboot eXecution Environment
RAM.....	Random Access Memory
RAMDAC.....	Random Access Memory Digital Analog Converter
RDRAM.....	Rambus Dynamic Random Access Memory
RIMM.....	Rambus Inline Memory Module
RTC.....	Real Time Clock
SB	Soundblaster
SDRAM.....	Synchronous Dynamic Random Access Memory
SGRAM.....	Synchronous Graphic Random Access Memory
SMBus.....	System Management Bus
SVGA.....	Super Video Graphic Adapter
USB.....	Universal Serial Bus
VGA	Video Graphic Adapter
WOL.....	Wake On LAN